

ATTREZZI SPECIALI

Per smontaggio, rimontaggio
e revisioni

SPECIAL TOOLS

For disassembling, reassembling
and servicing



ATTREZZI PER SMONTAGGIO, RIMONTAGGIO E REVISIONI
SPECIAL TOOLS

ATTREZZO - TOOL

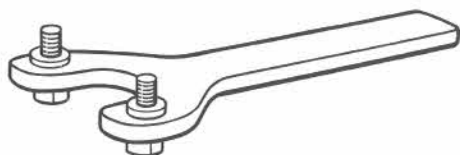

19.1.20086
Chiave arresto pignone
Sprocket locking wrench

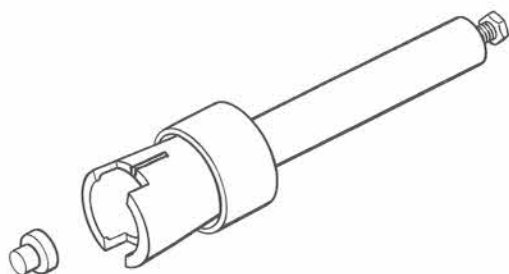

19.1.20109
Estrattore pista inf. cuscinetti sterzo
Puller for steering bearing lower race

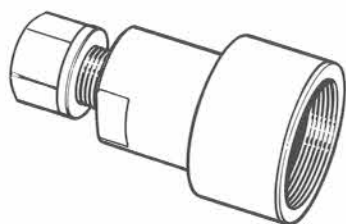

19.1.20501
Estrattore volano
Flywheel puller

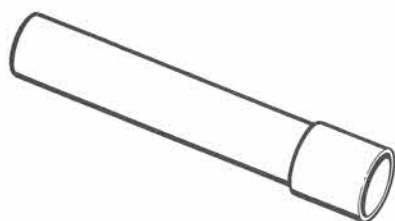

19.1.20502
Punzone mont. paraolio su guida valvola
Valve guide oil ring installation punch

ATTREZZO - TOOL

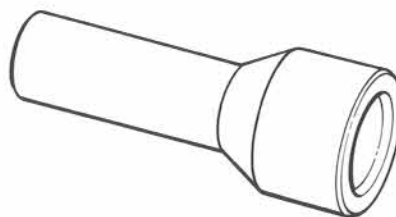

19.1.20503
Punzone mont. paraolio su assi a camme
Camshaft oil ring installation punch

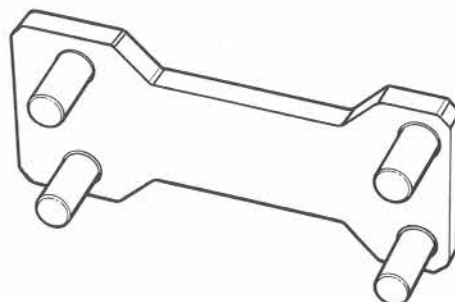

19.1.20504
Attrezzo bloccaggio pulegge su assi a camme
Camshaft pulley blocking tool

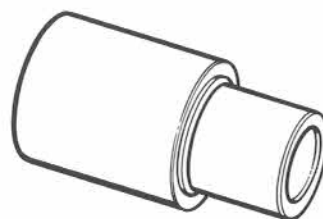

19.1.20505
Punzone mont. bronzina piede di biella
Con-rod small end bushing installation punch

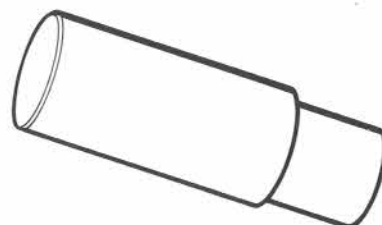

19.1.20506
Punzone estrazione bronzina piede di biella
Con-rod small end bushing extraction punch

ATTREZZO - TOOL

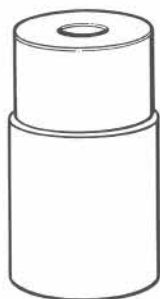

19.1.20507

Punzone estrazione bronzina di banco
Main journal bushing extraction punch

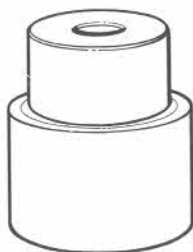

19.1.20508

Punzone montaggio bronzina di banco lato frizione
Main journal bearing installation punch (clutch side)

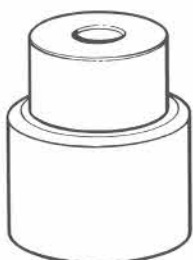

19.1.20509

Punzone montaggio bronzina di banco lato accensione
Main journal bearing installation punch (ignition side)



19.1.20510

Anello estrazione e montaggio bronzina lato frizione
Main journal bearing extraction ring (clutch side)

ATTREZZO - TOOL



19.1.20511

Anello estrazione e montaggio bronzina lato accensione
Main journal bearing extraction ring (ignition side)

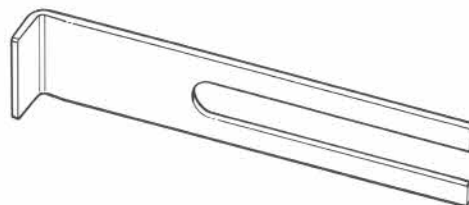

19.1.20512

Forchetta ferma pistone
Piston support



19.1.20513

Pastiglia per estrattore volano e albero motore
Pad for crankshaft and flywheel puller

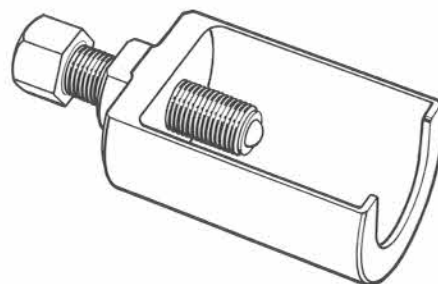

19.1.20514

Attrezzo smontaggio ingranaggio comando distribuzione
Timing drive gear puller

ATTREZZO - TOOL

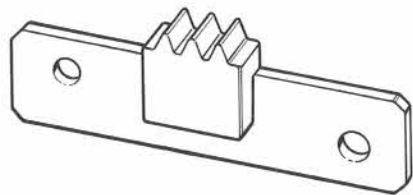

19.1.20515
Attrezzo fermo ingranaggi motore
Drive gear blocking tool

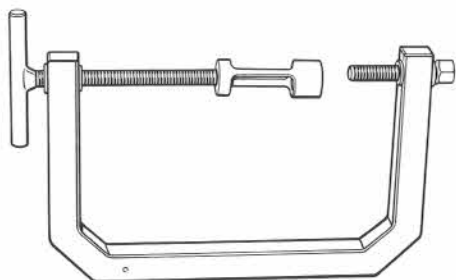

19.1.20519
Anello montaggio-smontaggio molle valvole
Valve spring compression tool

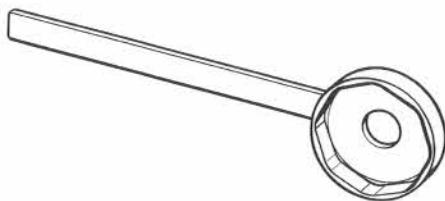

19.1.20520
Chiave per smontaggio cartuccia olio
Oil filter removal spanner

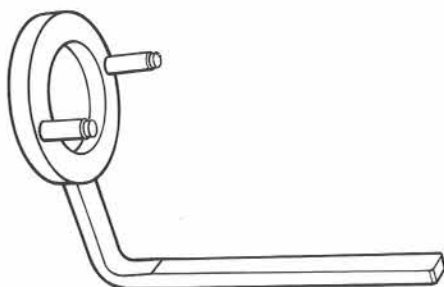

19.1.20521
Attrezzo fermo volano (sul veicolo)
Mounted flywheel blocking tool

ATTREZZO - TOOL

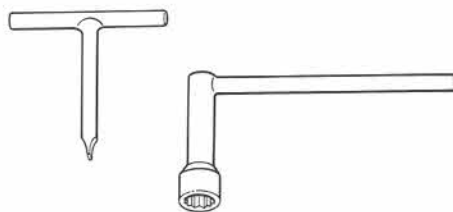

19.1.20522
Attrezzo per registrazione valvole
Valve clearance adjustment tool



19.1.20523
Punzone estrazione e montaggio guide valvole
Valve guide extraction/installation punch

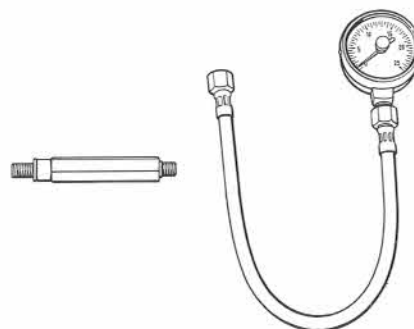

19.1.20524
Attrezzo per controllo compressione
Compression check tool



19.1.20525
Guaina montaggio anello di tenuta
Oil seal installation sleeve

ATTREZZO - TOOL

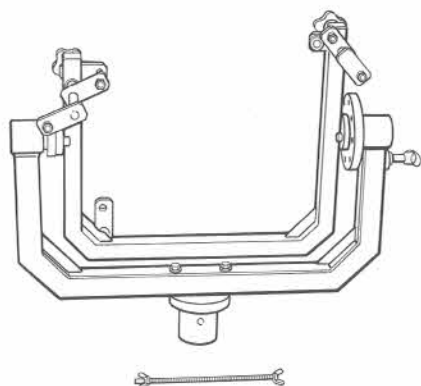

19.1.20526
Supporto motore
Engine support

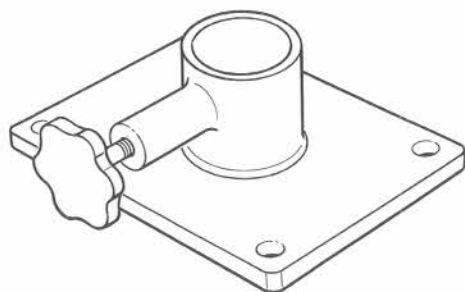

19.1.20527
Base per supporto motore
Engine support base

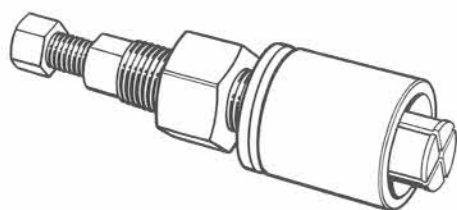

19.1.20528
Estrattore per gabbie a rulli completo
Complete roller cage extractor

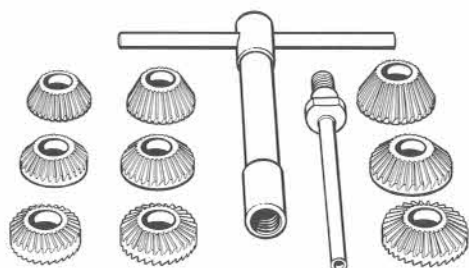

19.1.20529
Serie frese per sedi valvole
Reamer set for valve seats

ATTREZZO - TOOL



19.1.20530
Punzone per espulsione spinotto
Pin sliding punch

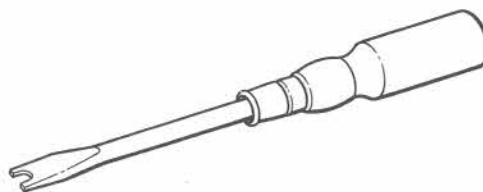

19.1.20540
Attrezzo per bussole frizione
Clutch collets tool

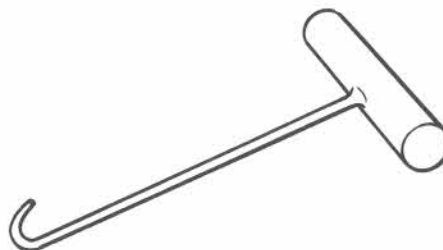

19.1.20551
Attrezzo per molle collettore di scarico
Exhaust manifold spring removal tool

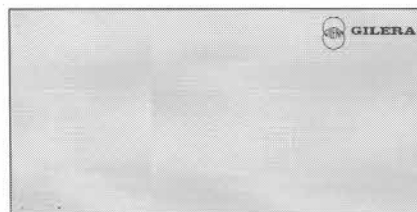

19.1.20563
Pannello espositore attrezzi
Complete tool set

ATTREZZI PER SMONTAGGIO, RIMONTAGGIO E REVISIONI
SPECIAL TOOL

ATTREZZO - TOOL

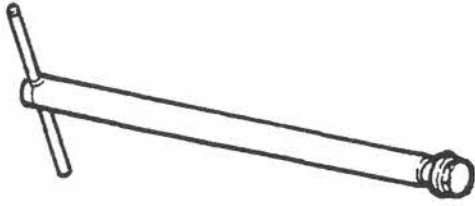

19.1. 20595

Attrezzo per forcella Kayaba
Kayaba fork tool

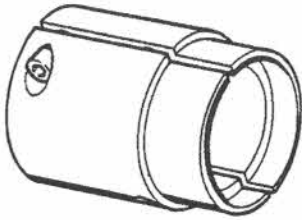

19.1. 20596

Semigusci per forcella Kayaba
Kayaba fork halves housing

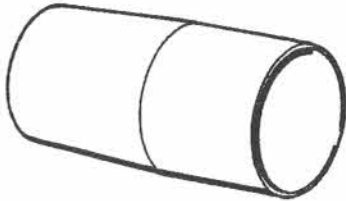

19.1. 20597

Punzone per inserimento paraolio forcella Kayaba
Kayaba fork fitting oil seal punch

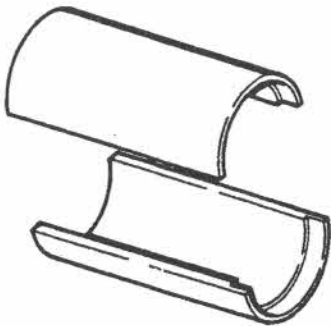

19.1. 20598

Semigusci per paraoli e DU forcella Paioli
Upside down
Paioli fork fitting oil seal tool (Upside down)

ATTREZZO - TOOL



19.1. 20599

Chiave a tubo per smontaggio forcella Paioli
Upside down
Paioli fork disassembling wrench (Upside down)



19.1. 20600

Punzone per inserimento forcella Kayaba
Kayaba fork fitting punch

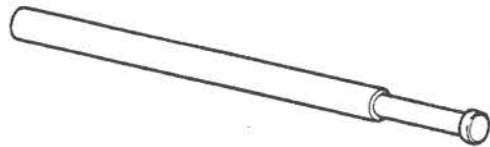

19.1. 20601

Attrezzo per forcella Kayaba
Kayaba fork tool

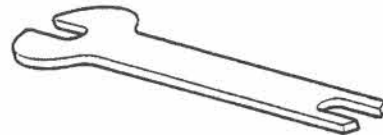

19.1. 20602

Chiave per forcella Kayaba
Kayaba fork wrench

ATTREZZO - TOOL

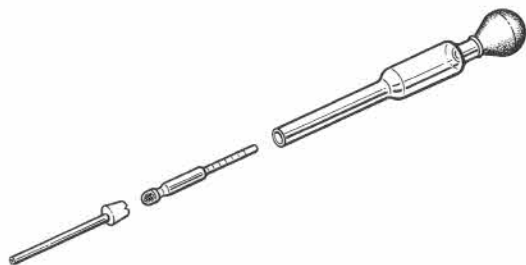

19.1.20564

Attrezzo per controllo stato di carica della batteria
Battery charge densimeter

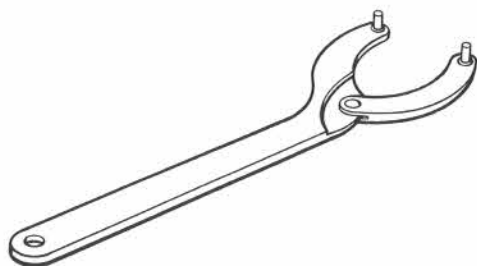

19.1.20565

Attrezzo regolazione tensione catena
Chain slack tool



19.1.20566

Punzone
Punch

ATTREZZO - TOOL

ATTREZZI PER SMONTAGGIO, RIMONTAGGIO E REVISIONI
SPECIAL TOOLS

ATTREZZO - TOOL

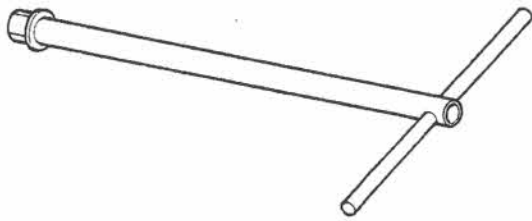

19.1. 20603

Attrezzo per forcella Kayaba
Kayaba fork tool

ATTREZZO - TOOL

